

NES-RY-USA

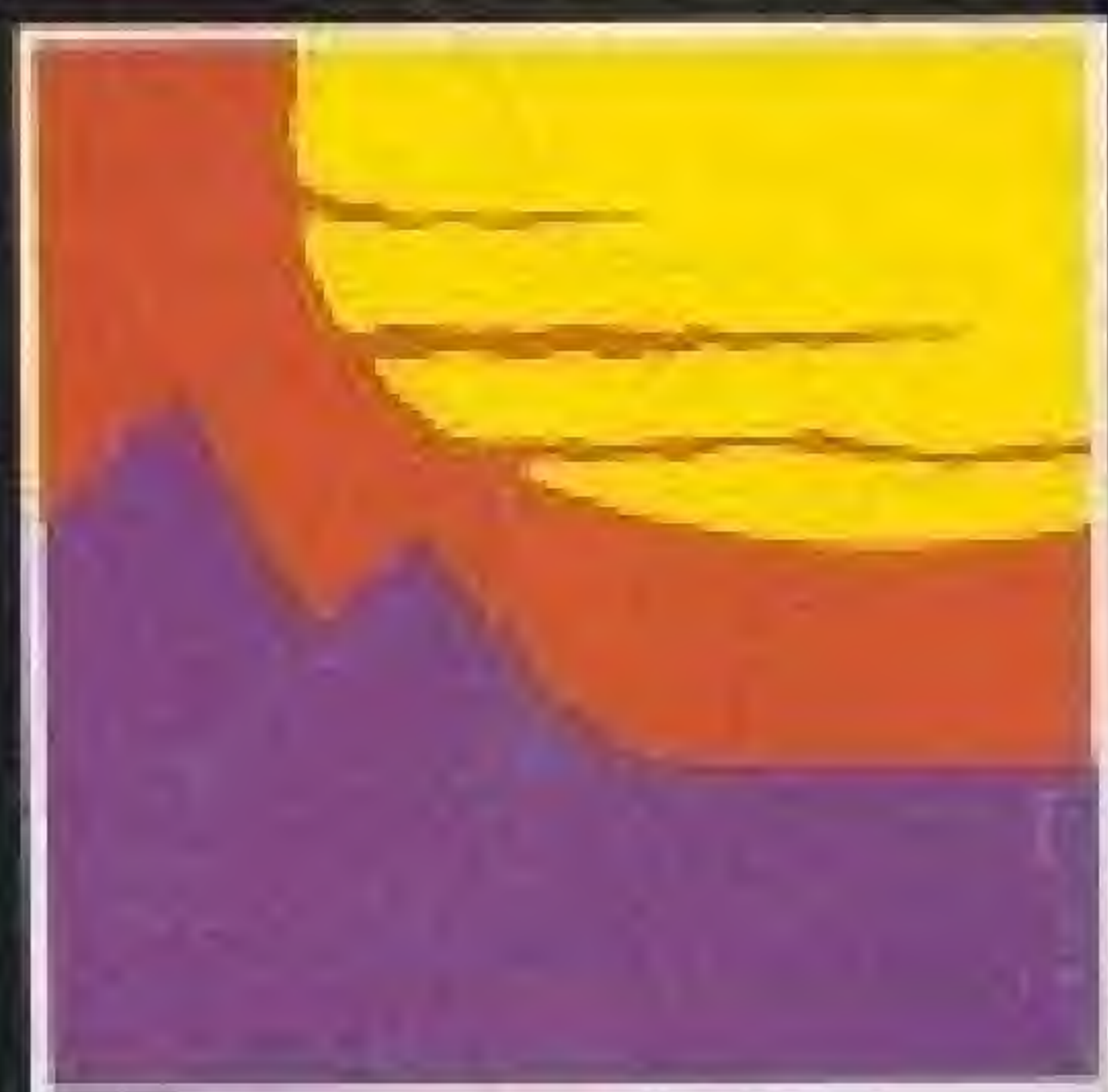

TECMO[™]
©1987 TECMO, INC.

THIS GAME IS
LICENSED BY NINTENDO
FOR PLAY ON THE



ENTERTAINMENT
SYSTEM

Printed in Japan

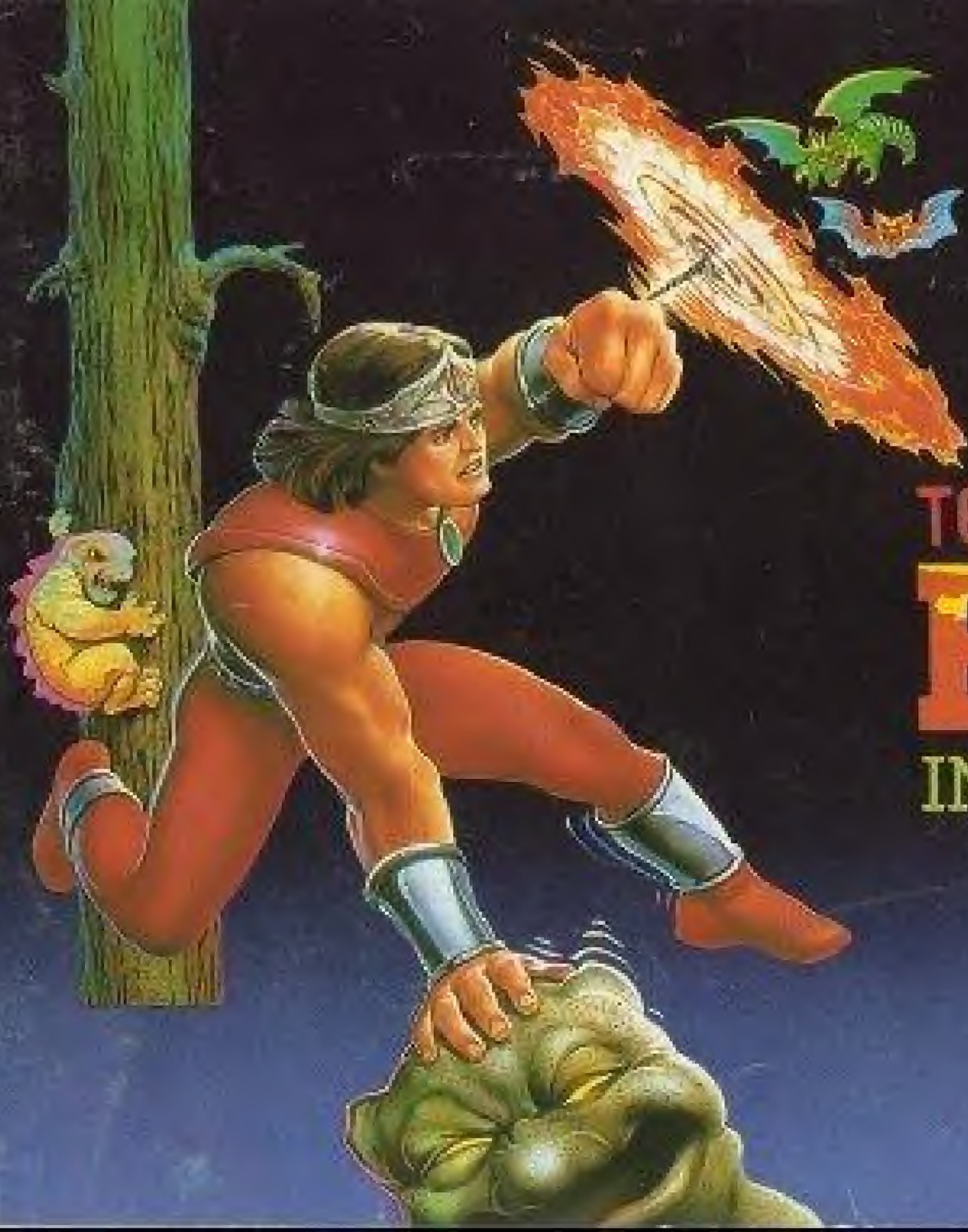

TECMO[™]
RYGAR[™]
INSTRUCTIONS

Thank you for selecting the fun-filled "RYGAR" game pak by
TECMO, INC.

SAFETY PRECAUTIONS

Please take time to read the important instructions in this booklet. Observing the step by step instructions and complying with warnings will be your personal guarantee to greater game satisfaction over a long period of time.

- 1) Avoid subjecting this high precision game pak to extreme temperature variances and tremendous shock. Furthermore, never attempt to disassemble your game pak.
- 2) Do avoid touching terminal connectors, and keep clean by inserting game pak in protective STORAGE case.
- 3) Use of thinners, solvents, benzene, alcohol and other cleaning agents can damage the game pak.
- 4) For best results, play the game a distance away from your television set.
- 5) Pause for 10-15 minutes after 2 hours of more of continuous game playing. This will extend the performance of your game pak.

* Please note that this game has been programmed to take advantage of the full screen. Some older models have rounded screens and may block out a portion of the image.

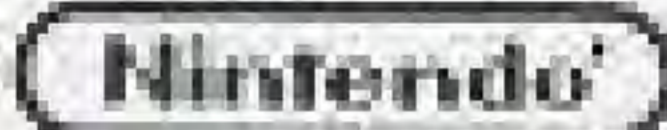
THIS GAME IS
LICENSED BY NINTENDO
FOR PLAY ON THE

ENTERTAINMENT
SYSTEM.



NINTENDO AND Nintendo ENTERTAINMENT SYSTEM
ARE TRADEMARKS OF NINTENDO OF AMERICA, INC.

TABLE OF CONTENTS

1. GEOGRAPHICAL FEATURES OF A HOLY PLACE, ARGOOL	p 4
2. MAP OF GRAN MOUNTAIN	p 6
3. GAME STORY	p 8
4. CONTROLLER PARTS AND OPERATING INSTRUCTIONS	p 9
5. SUB-SCREEN	p 11
6. FIRST OF ALL, GO TO MEET THE LENGENDARY	p 12
7. LOOK FOR INDORA'S FIGHTING GODS	p 14
8. POTENTIAL CAPACITIES OF RYGAR	p 16
9. ANIMALIZED MEN WRIGGLING EERILY	p 17
10. EPILOGUE	p 19
11. RESURRECTION	p 20

1. GEOGRAPHICAL FEATURES OF A HOLY PLACE, ARGPOOL

START

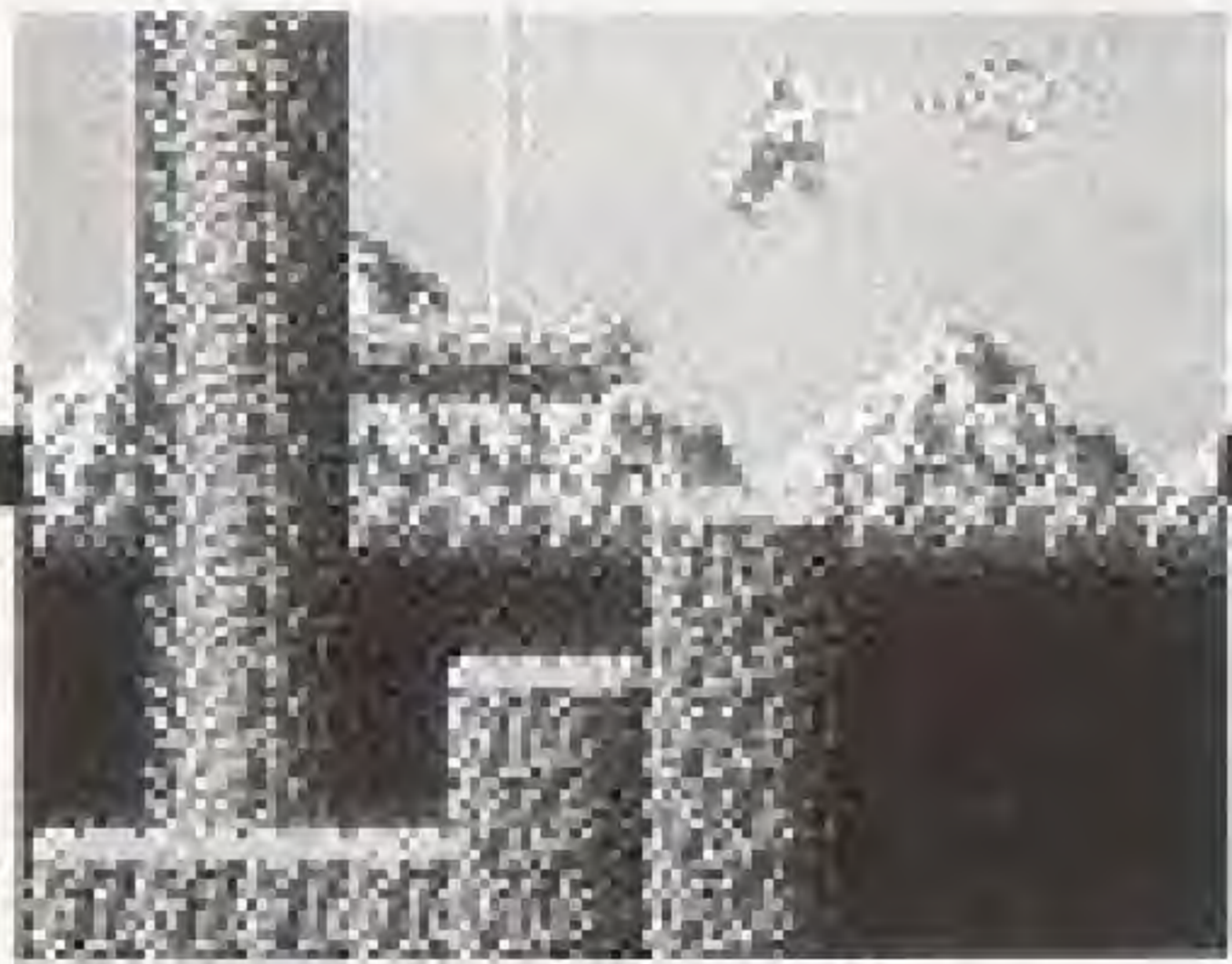

SUERU MOUNTAIN

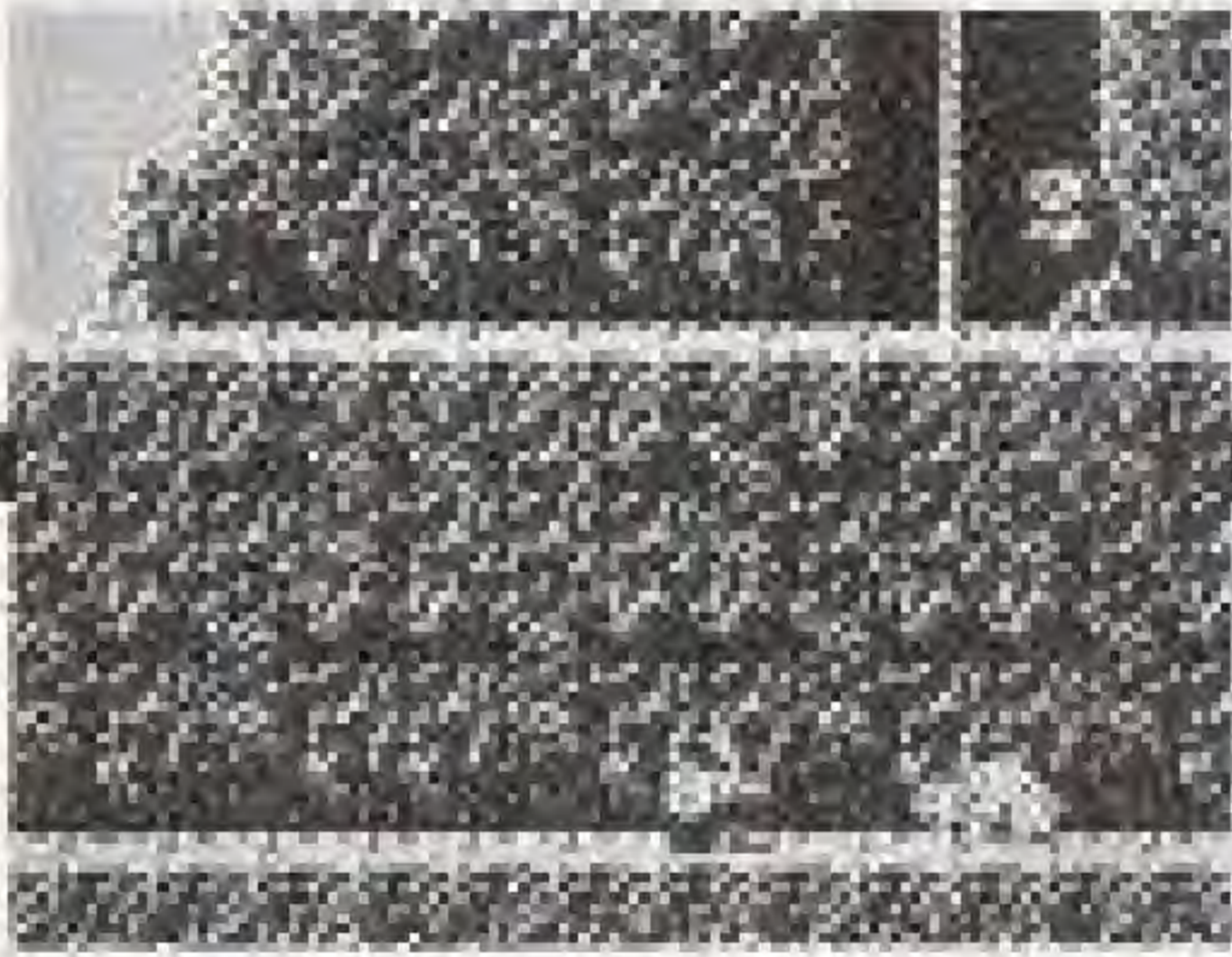

GRAN MOUNTAIN

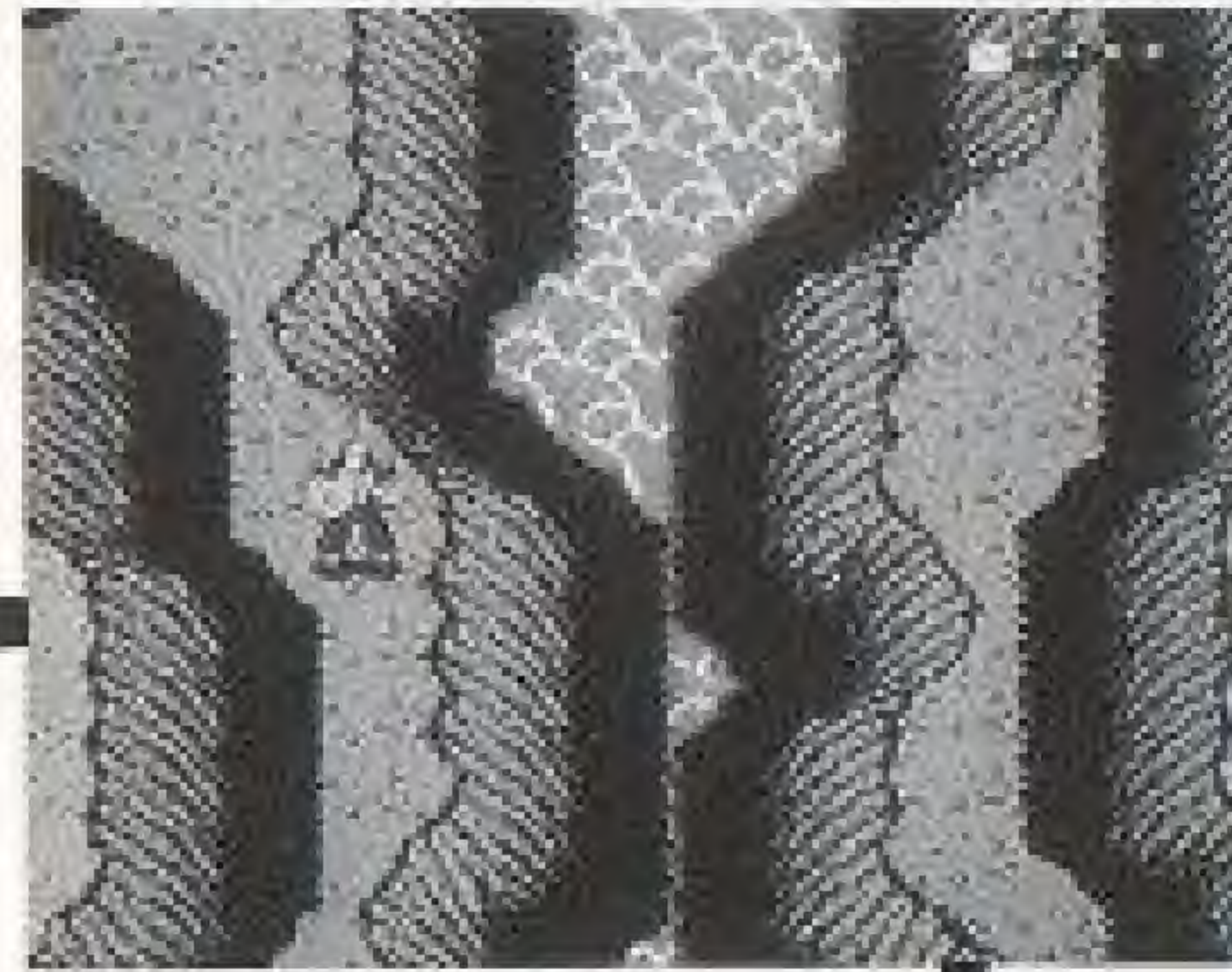

GALOZ

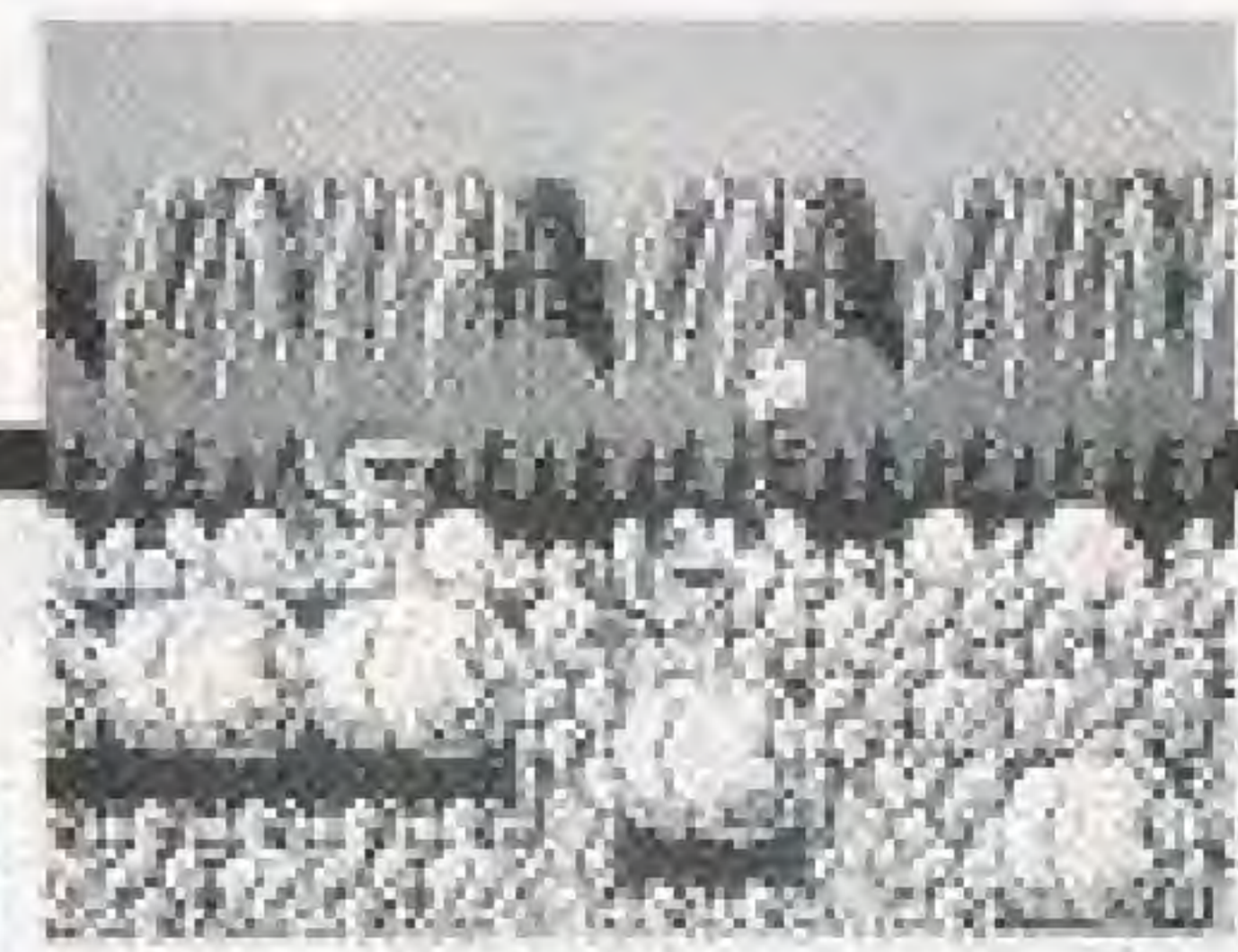

ROLSA

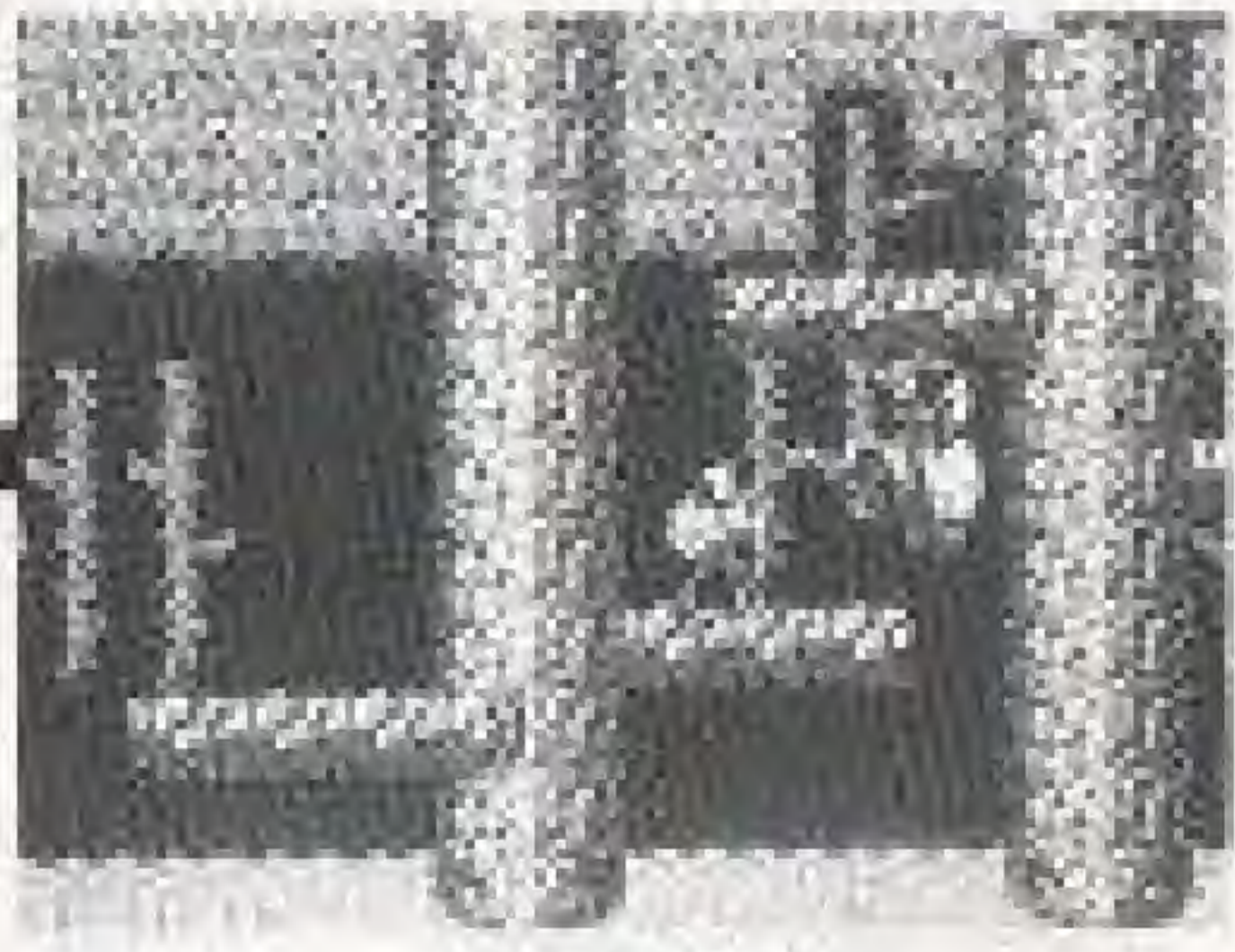

ERUGA

Argool is connected with many places through gates, with the Garloz valley as the center.



GATE OF GARLOZ

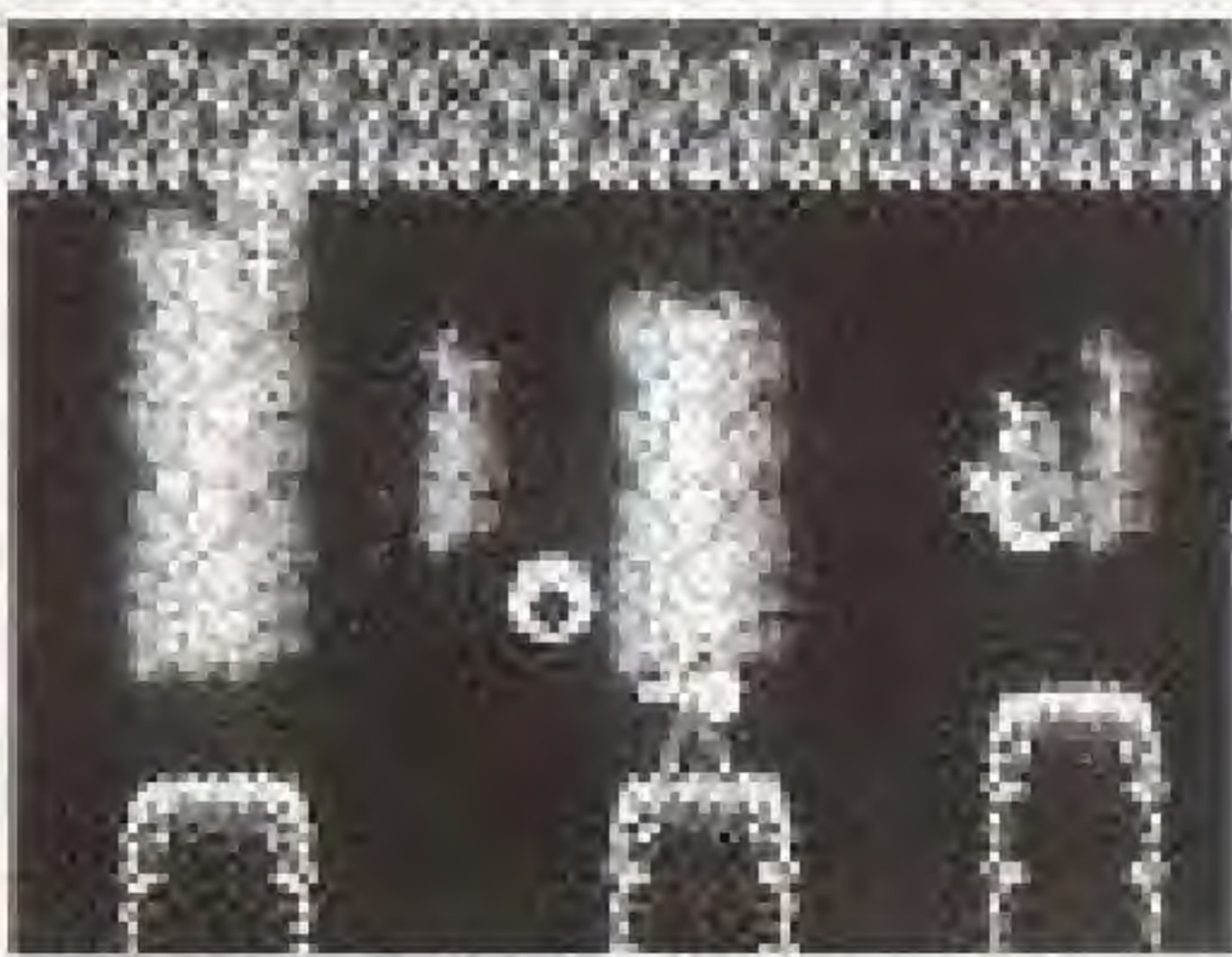

DEN OF SAGILA



PRIMEVAL MOUNTAIN



RAGUA SANDO

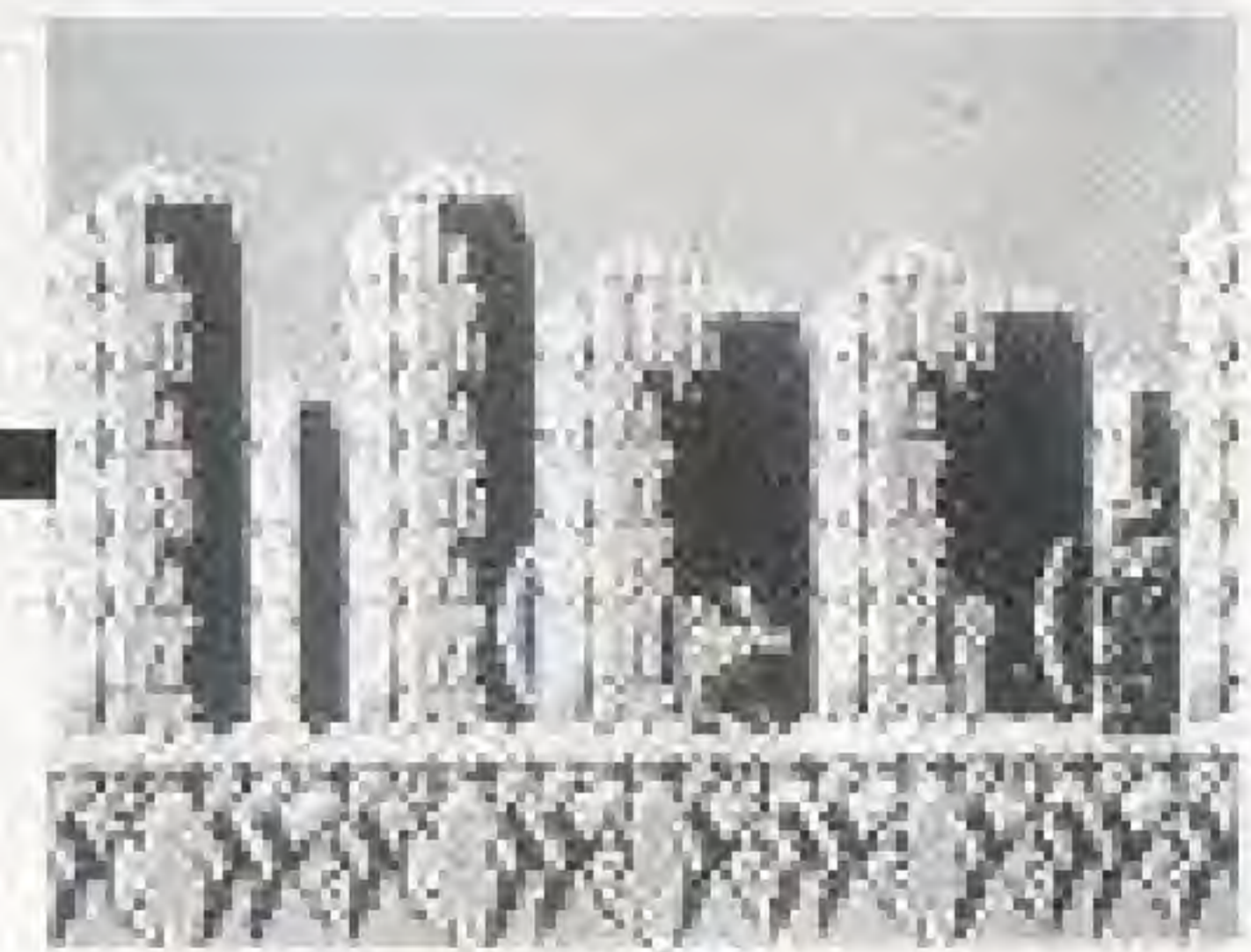

LAPIS

2. MAP OF GRAN MOUNTAIN

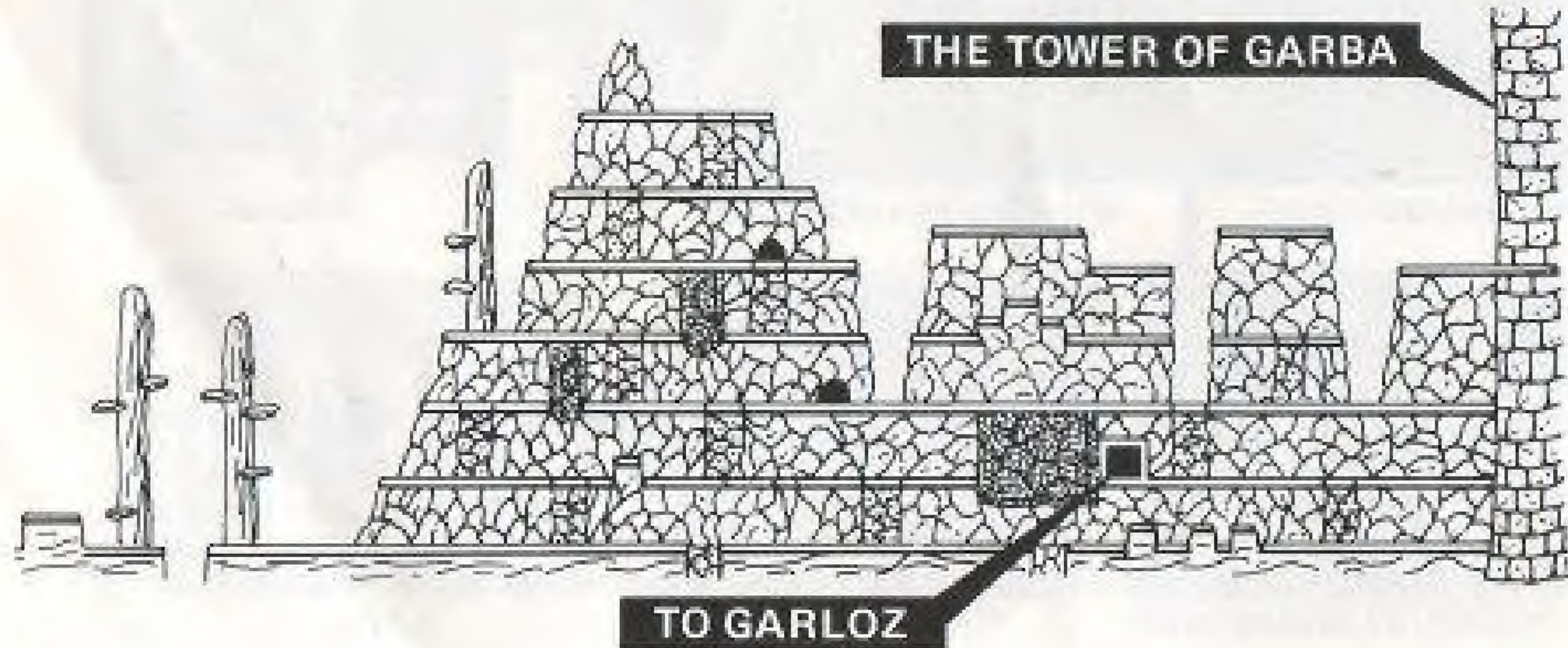

MAP OF GARLOZ

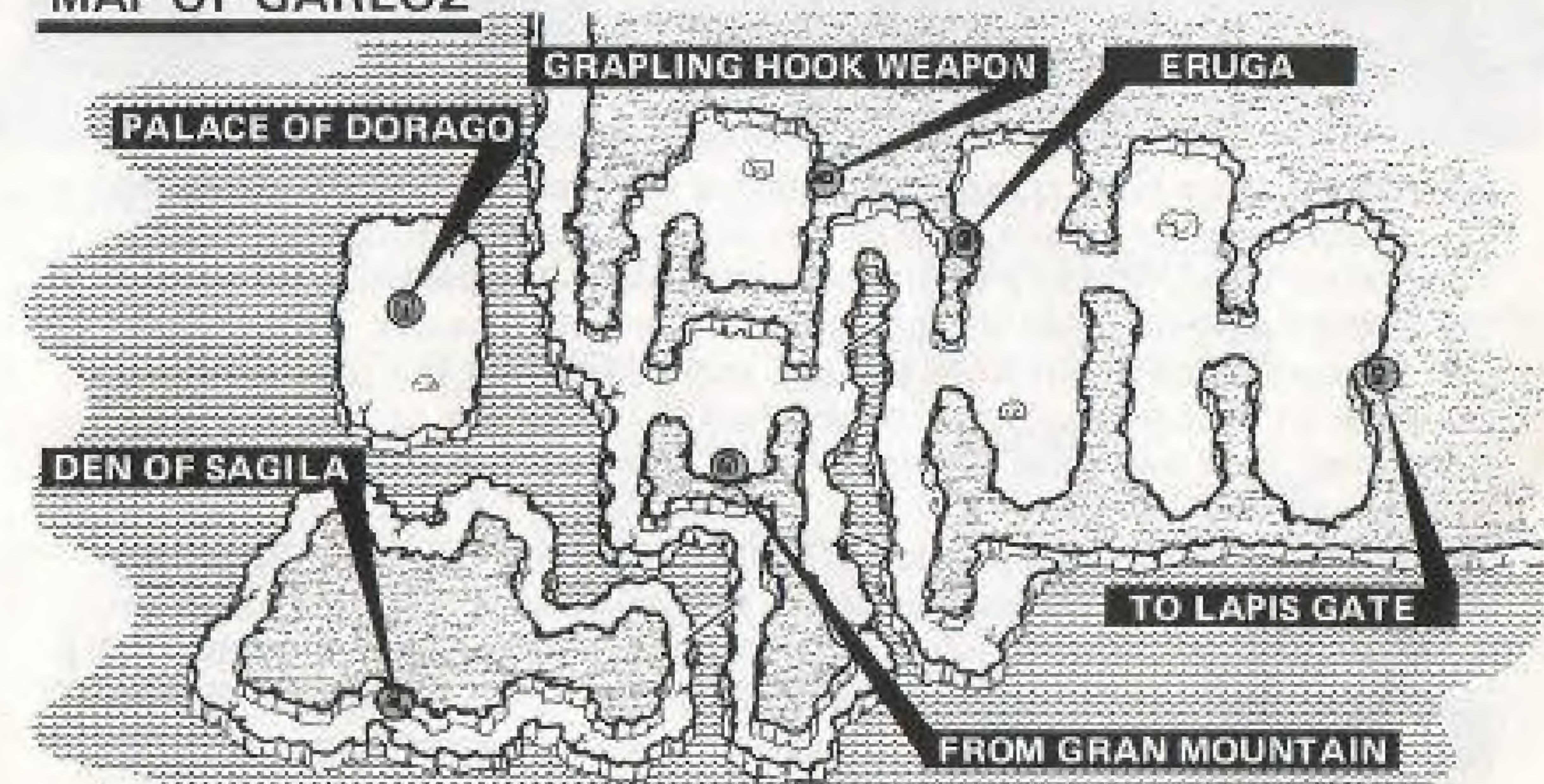

You can get the following items from each region.

- Eruga Wind pulley
- Den of Sagila Crossbow
- Lapis Coat of arms
- The palace of Dorago Indora's suit of armour
- The tower of Garba Flute of Pegasus

3. GAME STORY

Once there was a holy place called Argool which was founded by five legendary Indora Gods. One day, suddenly the blackest tragedy happened. The prosperous holy place, Argool was attacked by the troops of the cruel king called Ligar. The sky of the holy place was completely covered with the flying castle of Ligar and his army of dangerous beasts. These animalized soldiers came down from the sky and committed the most atrocious cruelties. In a single day, they established the kingdom of EVIL. In addition, Ligar took away the "Door to Peace" symbolizing the peace that had been created by Indora.

The hope for peace disappeared with the loss of the "Door to Peace" and the people of Argool ceased to smile and could only pray for salvation. They prayed an ancient passage to counter the fulfilled prophecy of Ligar's evil reign of terror. The legend says, "When the peaceful land is covered with EVIL SPIRITS, a brave soldier will be brought to life from the dead, for the purpose of saving persecuted people. The people of Argool's painful prayers were so loud that it reverberated throughout the mountains and traveled a long distance in the land of Algosu. And at last — Rygar, the hero came back from the dead in order to restore peace to the land of Argool, battling the forces of evil everywhere. Join forces with Rygar!

4. CONTROLLER PARTS AND OPERATING INSTRUCTIONS

★ THIS GAME IS ONLY A (1) PLAYER GAME.

4-A CONTROLLER PARTS

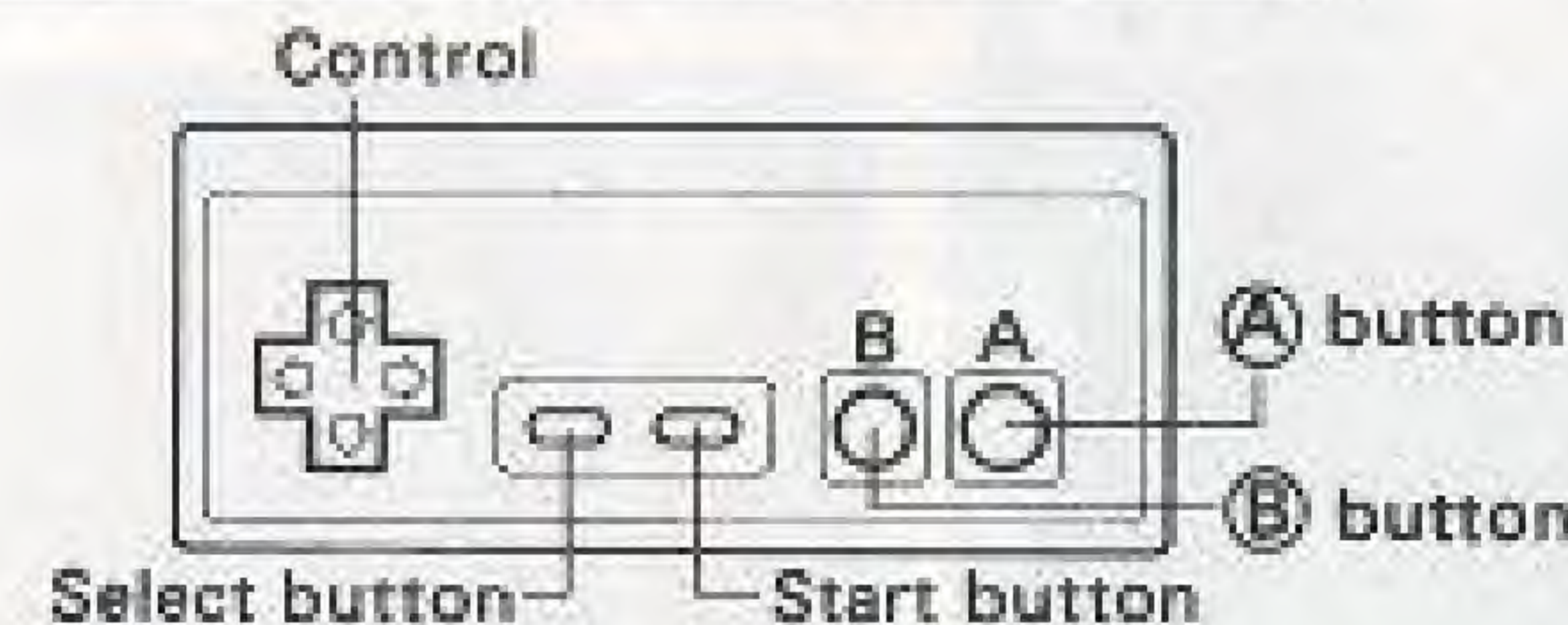

● START BUTTON

Press START button during the game to display a sub-screen.

● PAUSE

If you wish to PAUSE, or interrupt play in the middle of a game, press the SELECT button. Press the SELECT button to continue.

4-B OPERATING INSTRUCTIONS

HOW TO OPERATE RYGAR

Move this  control pad to move Rygar. The following movements are available.



Rygar runs left



Rygar runs right



Rygar crouches down



Rygar climbs up

(A) button . . . JUMP • To make Rygar jump press **(A)** button.

(B) button . . . ATTACK • To make Rygar attack press **(B)** button.

Rygar can attack in many positions: on the run; while crouching; while climbing; and even while airborne. You can also attack an enemy in the forward position.

Rygar can run left or right. Also, in "Garloz" Rygar is able to run in four directions, and can jump in eight directions.



Some enemies will faint if trampled upon.



The weapon used frequently by Rygar is called a Diskarmer.

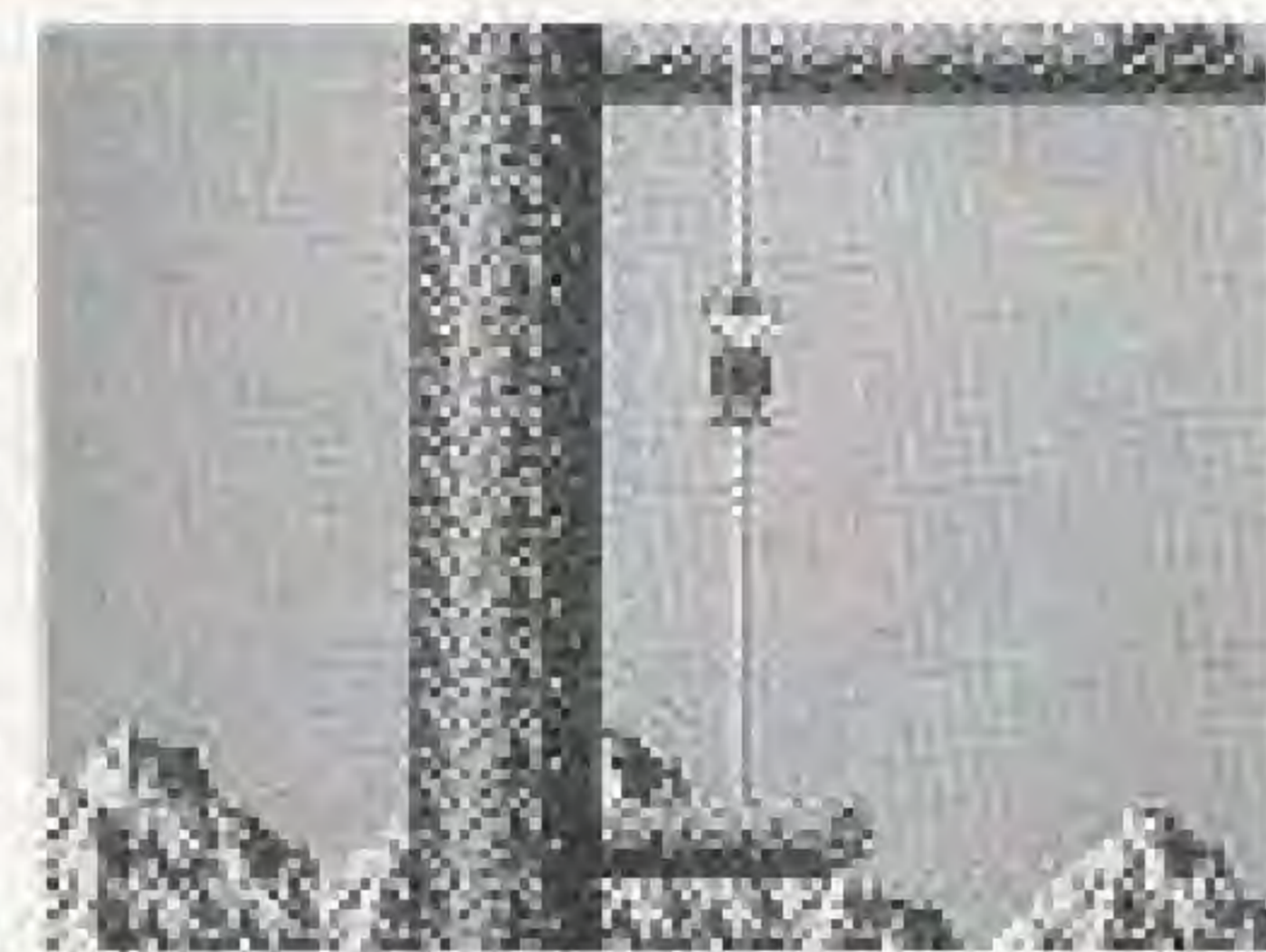

Climb





When Rygar reaches a rope and you wish to climb, simply press the control pad's upper directional arrow – to climb up, or press the control pad's lower  directional arrow – to climb down.

NOTE: The mastery of the above mentioned operations will allow the player to advance to the difficult stages / rounds / levels of the game and achieve an increased level of game satisfaction!

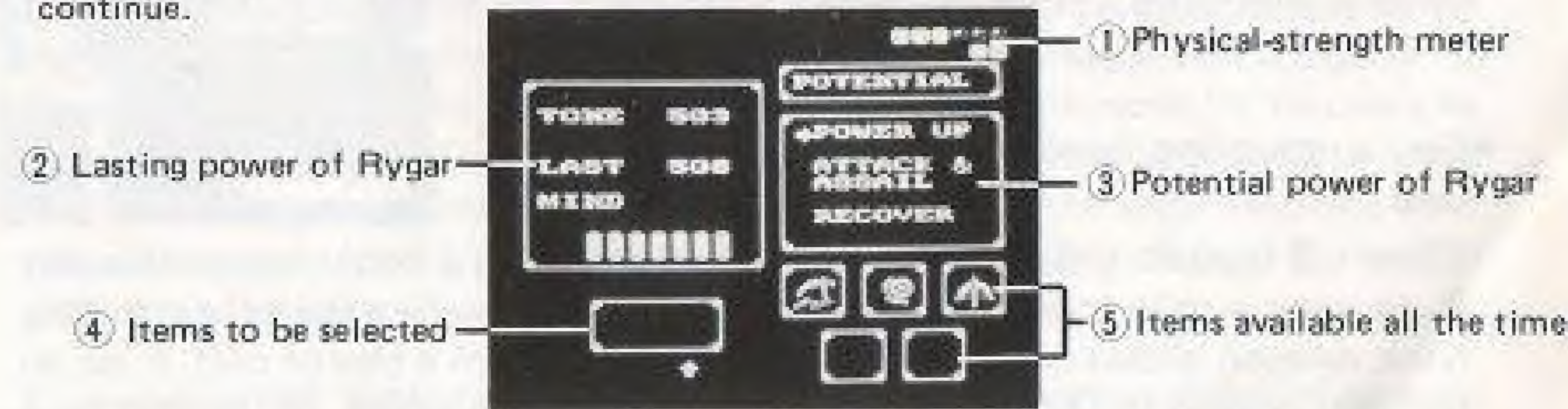
5. SUB SCREENS

Pressing the START button during the game displays sub-screens which shows the present status of Rygar. To re-start the game, simply press the START button again to continue.



1. Physical-strength meter: This value represents the physical strength of Rygar. If the value comes down to zero, Rygar dies. The game starts with the value of 3, but it increases every time you defeat an enemy. The maximum value is 12.
2. Lasting power of the Rygar: With the increase in the number of defeated enemies, Rygar is powered up in terms of Tone (striking power) and Lasting power (durability). These items make Rygar more powerful.
3. Potential power of Rygar: Move  through the vertical movement of the  button for selecting a function and use (A) button for decision-making. (For further details, see page 16.)
4. Items to be selected: Move  through the horizontal movement of the  button and use (B) button for decision-making. (For further details, see page 13 and page 15.)
5. Items available all the time; All the items on hand are displayed. They can be used at any time. (For further details, see page 14, 15.)

6. FIRST OF ALL, GO TO MEET THE LEGENDARY

- First of all, seek wisdom from the legendary God, listen to him as he will teach you lots of things.

- Get a grappling hook weapon from a legendary God.



There is a legendary God who will give you a grappling hook weapon. Usually Rygar uses a rope for vertical movement. In addition, the use of a grappling hook weapon allows him to go up or come down from a tree or cliff. First set the **+** button to UP position or DOWN position and use **(B)** button for a grappling hook weapon to be lengthened and caught on a tree nearby a cliff. Now Rygar is free to climb up or down a tree or a cliff. But remember that the position of a hill he can climb up or down is limited.



Door of a legendary

Once you get a grappling hook weapon, use it in various situations. It is also possible for the weapon to be caught by a tree or a hill outside the screen. In Lapis, go down to see a lot of places to make sure of geographical features.

There are many legendaries isolating themselves from society for ascetic practices. These hermits will help Rygar to be refreshed.

- Recovery of the physical strength

Some legendaries are of assistance in the recovery of physical strength of the wounded and physically weakened Rygar. With some legendaries, Rygar is refreshed by seeing them. With others, they give him medicine for recovery of his physical-strength. But unless Rygar has a coat of arms given only to brave warriors, he is not allowed to get the medicine. For the medicine, display a sub-screen and move 1 through the horizontal movement of the **+** button for item selection and use **(B)** button for decision-making.

1. Grappling hook weapon of a legendary



2. Medicine for physical-strength recovery



3. Coat of arms



7. LOOK FOR INDORA'S FIGHTING GODS

In Argool, five fighting gods called Indora are imprisoned. Make every effort to find them. You can make Rygar more powerful by receiving the five sacred treasures from them.



————— The five sacred treasures of Indora's —————

1 Wind pulley

Pressing the  button allows Rygar to walk a rope stretched between two wooden stakes if he gets a wind pulley.

- The knack of suspending a wind pulley from a rope successfully is to approach near the rope and move vertically.

<HINT> Near the waist of "RYGAR"

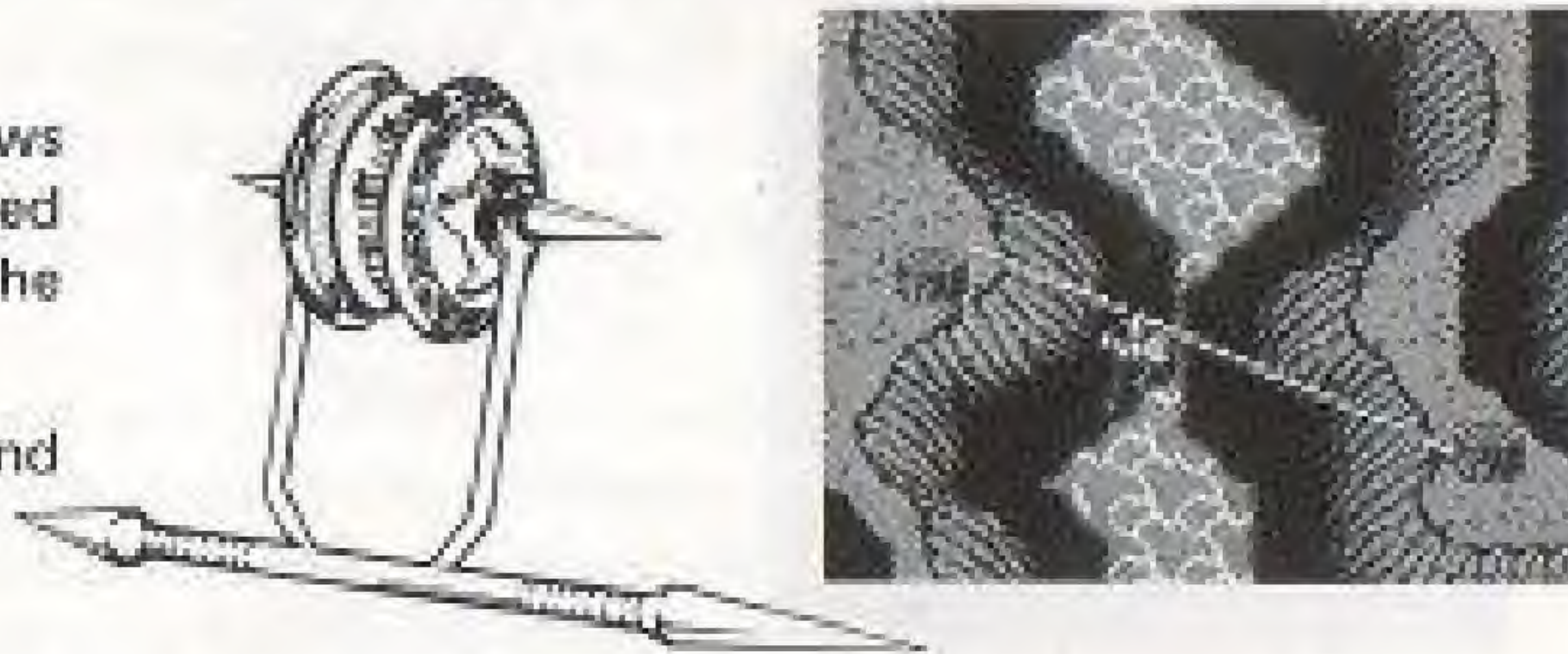

2 Crossbow

The use of a crossbow will allow a rope to be stretched by pressing the  button when Rygar reaches the stake of a tree with no rope wrapped around it.

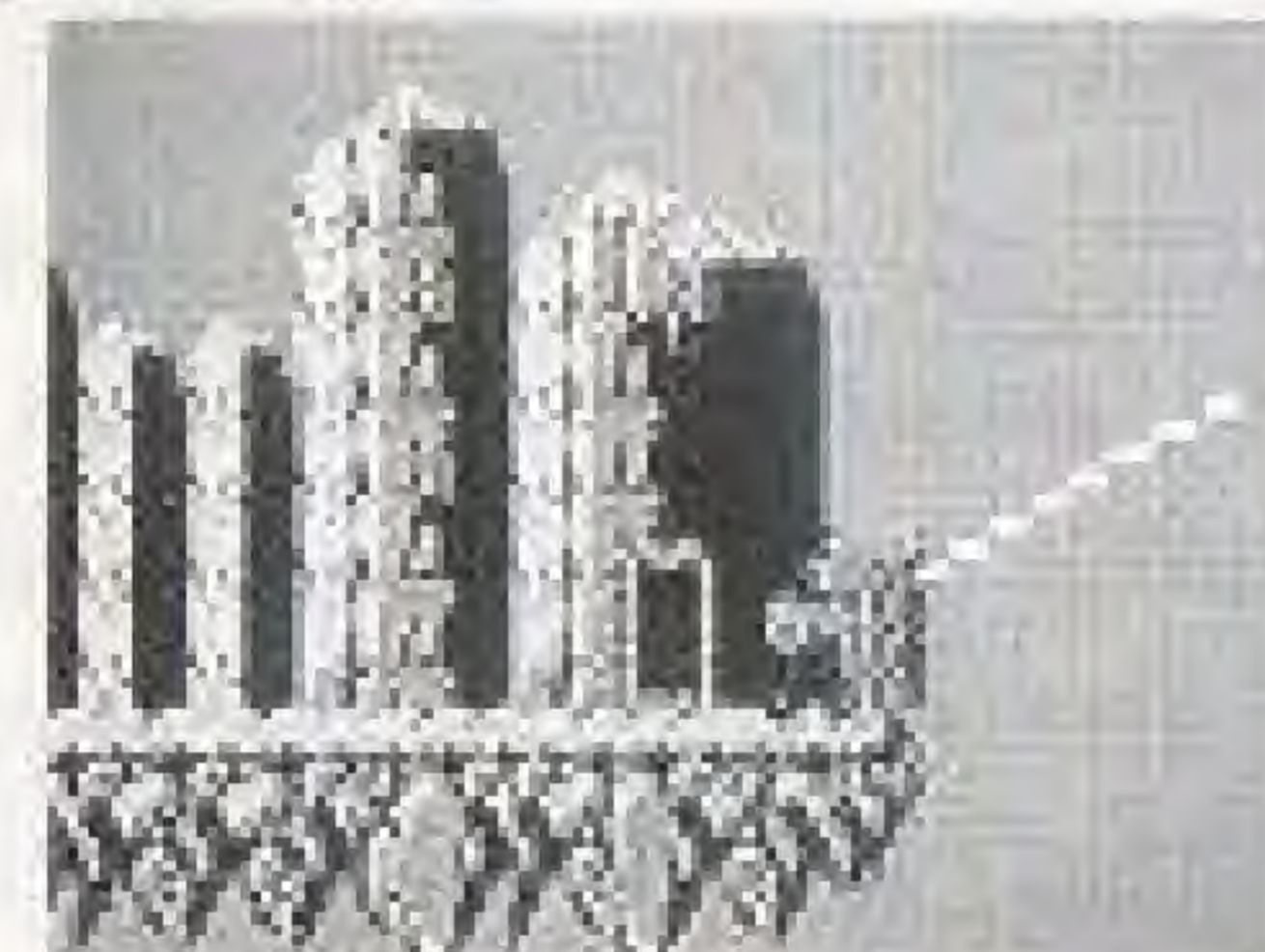
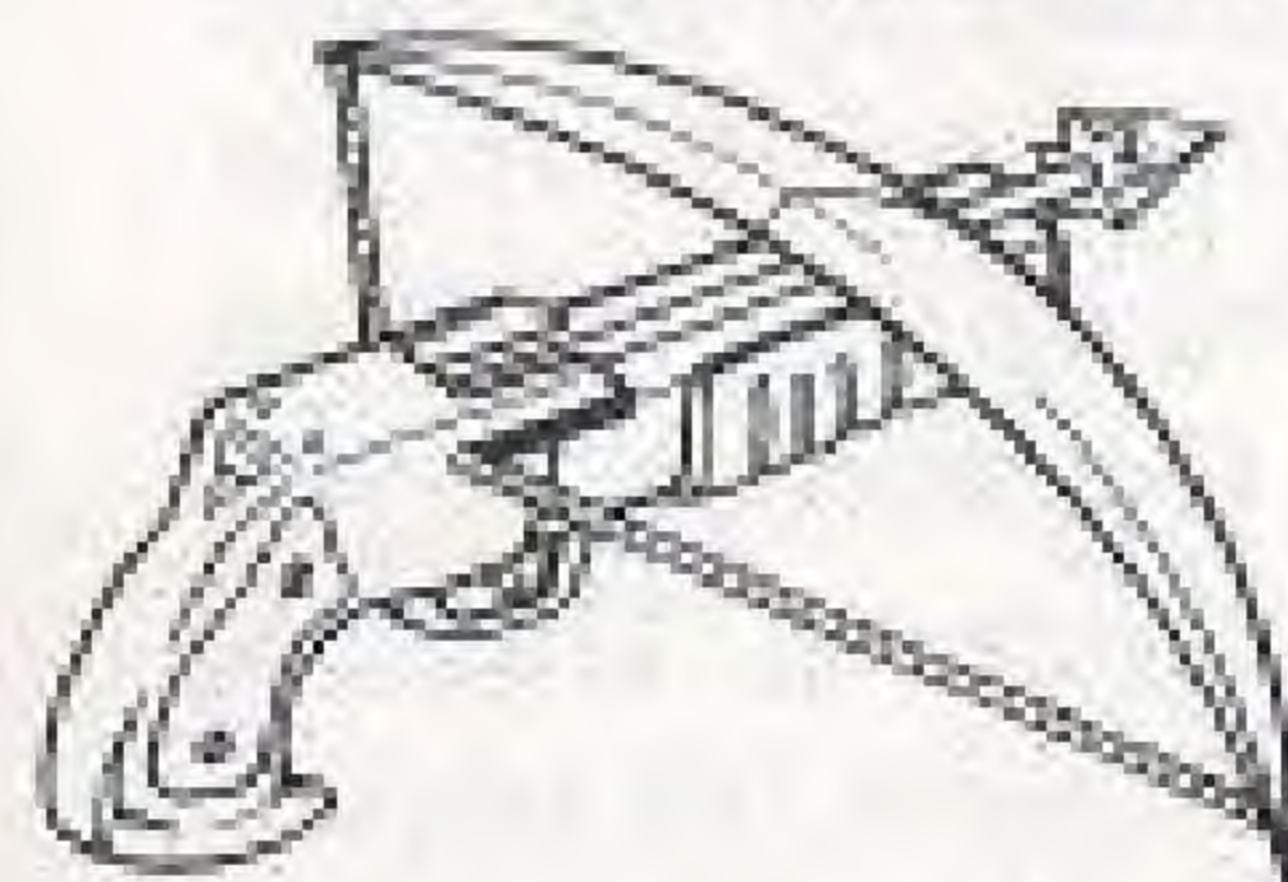

4 Indora's suit of armor

This suit strengthens the lasting power.



3 Coat of arms

If Rygar gets this crest, he will be qualified to receive the medicine for physical-strength recovery.

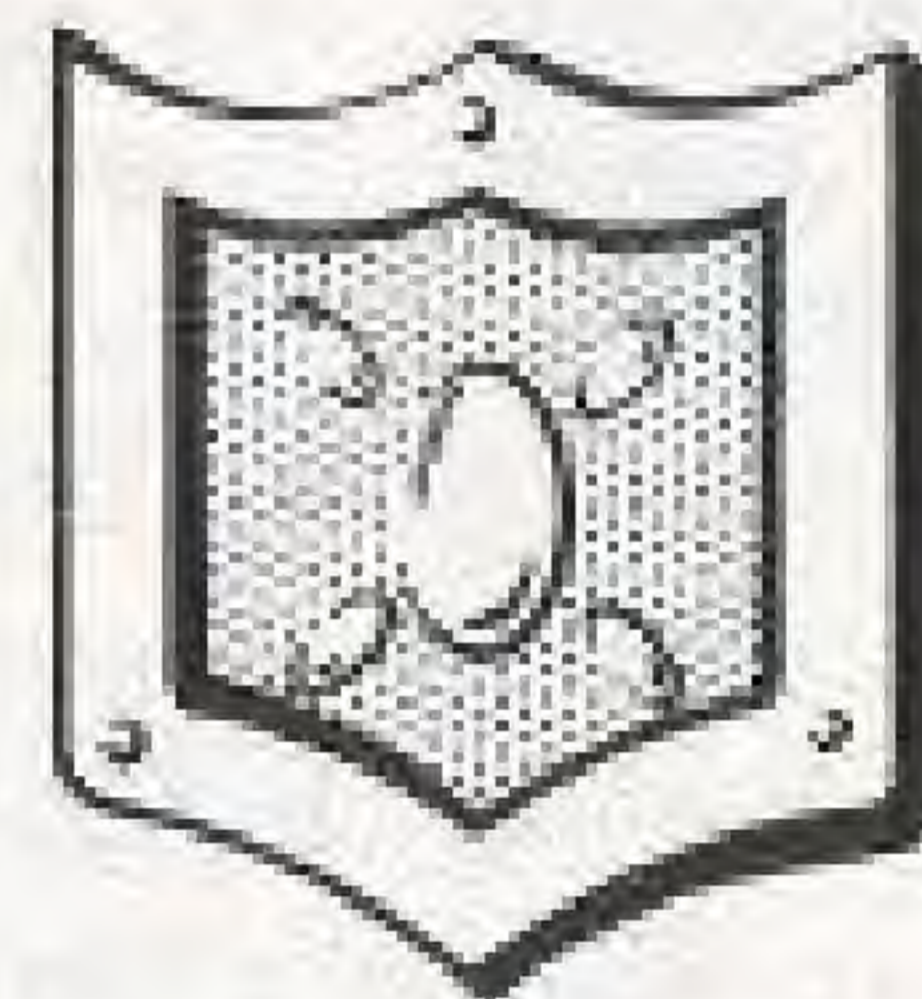

5 Flute of Pegasus

This is an ancient & strange flute. It is said that the sound will work miracles, use the  button.



8. POTENTIAL CAPACITIES OF RYGAR

In some cases, he is given a capsule for an increase in spiritual strength if he kills a monster. His spiritual strength is displayed on a sub-screen (mind-strength meter). There are two kinds of capsules. The capsule on the right hand will increase his spiritual strength by one unit and the capsule on the left hand by three units. Up to seven units can be added to his spiritual strength. First, display a sub-screen. Then, move → through the vertical movement of the **+** button and use the **(A)** button for decision-making. This operation consumes a certain amount of spiritual strength and causes his potential capacities to be available.



1 Power-up (Mind strength #3 used):

Allows the grappling hook weapon to be stretched.
(To be used only once)

2 Attack & assail (Mind strength #5 used):

Pressing the **(B)** button does damage to all the displayed enemies. (Can be used ten times)

3 Recover of physical strength (Mind strength #7 used):

His physical strength will be recovered when the physical-strength meter indicates the maximum value allowed.

9. ANIMALIZED MEN WRIGGLING EERILY



► Molgolin

It builds a nest in a den or on a high place. Once it finds Rygar, it will chase him tenaciously.

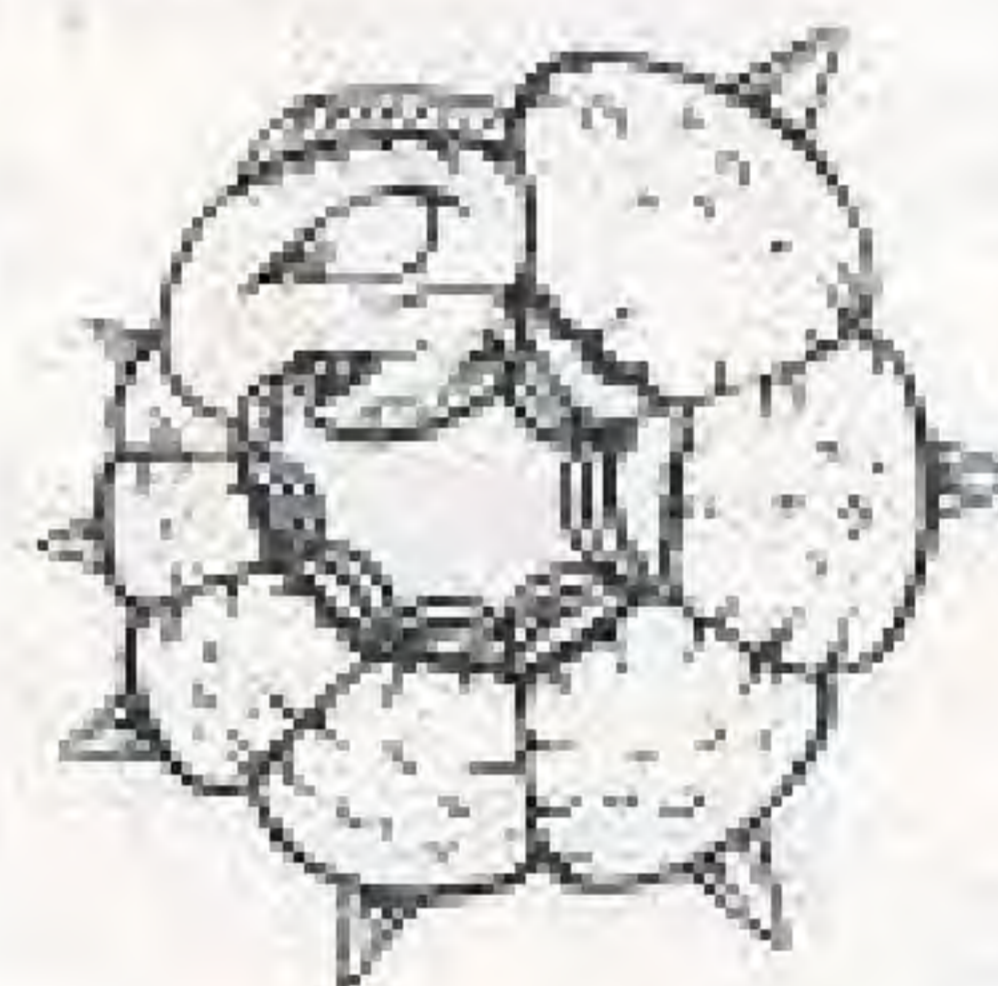

▼ Kinatarnos

Usually it lives at the waterside and throws a poisonous spine by bending itself backward. Turn a spine aside and attack it in a crouched position.

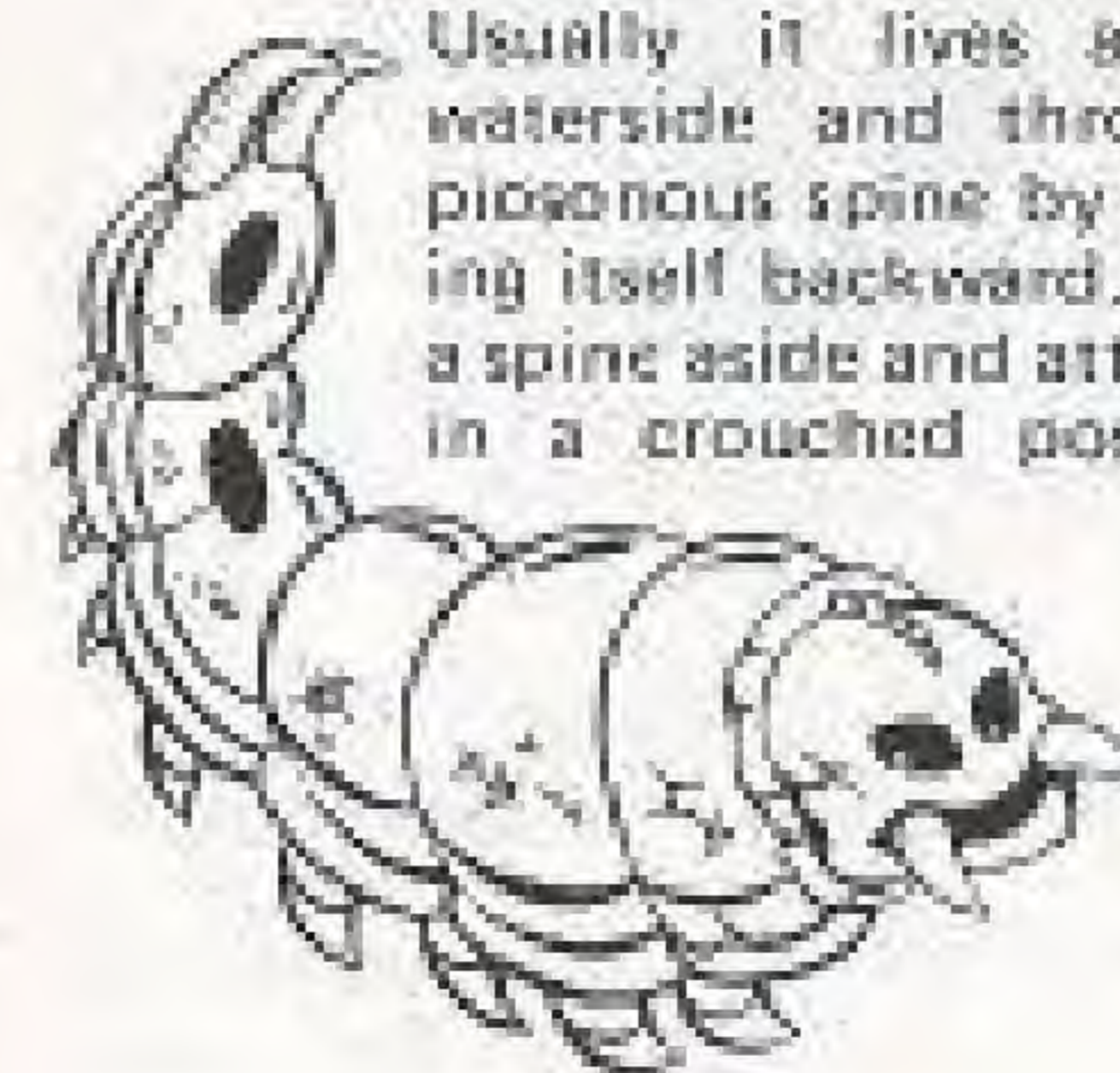

▲ Pragokelis

It is a primitive monster having been brought to life from the dead by Ligar. Attack it in a crouched position.

▼ Rolpher

It lives in the ground. Sensing someone approaching, it comes out and attacks him by rotating itself.

► Epolcon

It is a flying dragon which has been living in a primeval mountain. He will attack Rygar by dropping eggs of a snow grouse.



◀ Deathpigor

It lives in the tower of Garba and has two heads. It attacks Rygar by blowing demonic fire.

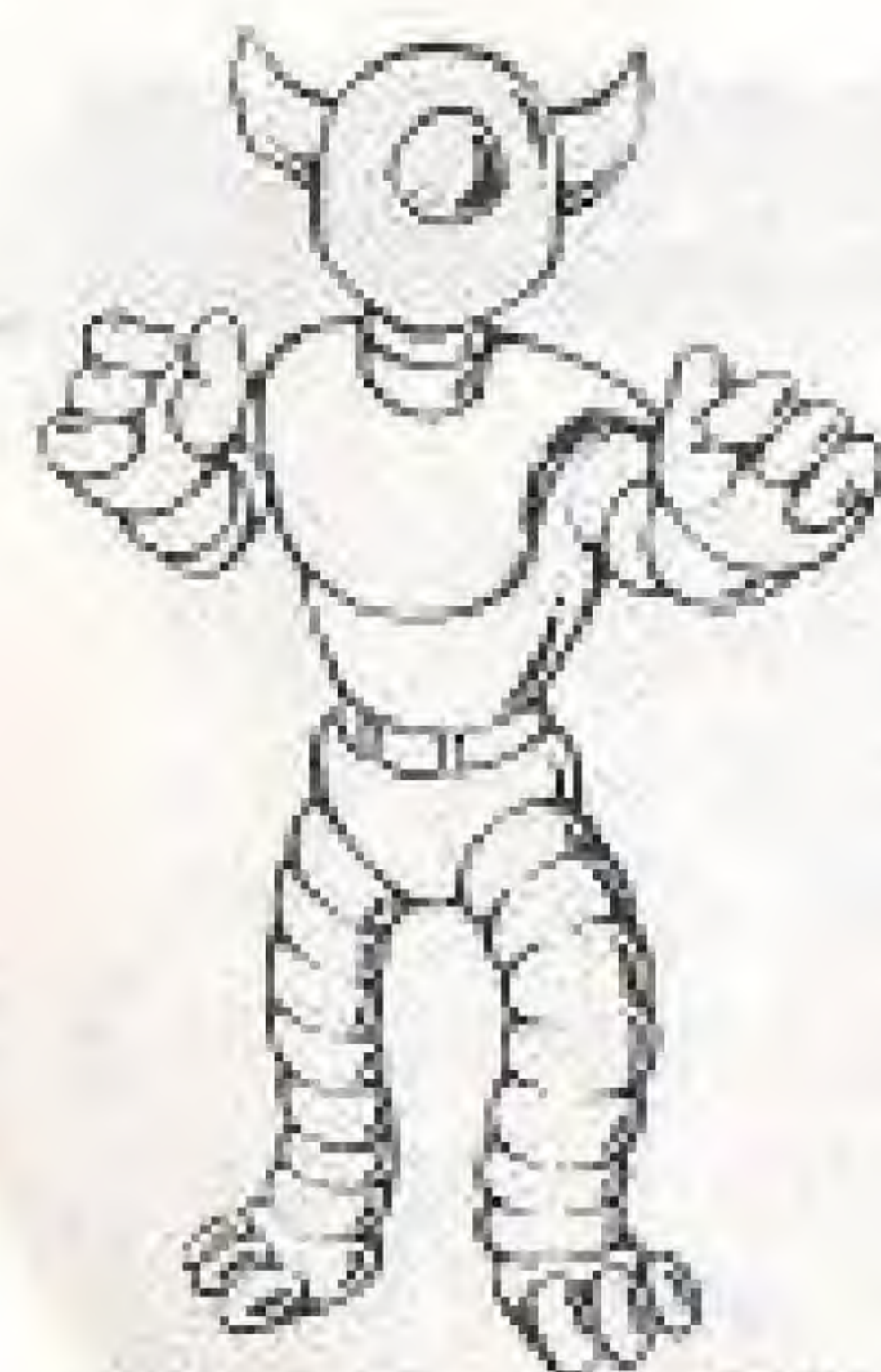

▲ Super-robot, Bargan

It was designed for the purpose of having command of the sky of Lapis and is capable of discharging deadly electromagnetic super wave.

▼ Demorobruzer

It has a heavily-equipped tank and advances along a wall. Sometimes it zooms down.



▼ Hyoking

It lives in the ground. Sensing someone approaching, it comes out and attacks him. After that, it goes back into the ground. Its body is covered with hard skin.



▶ Kuzeelar

Though it moves slowly, it attacks Rygar by discharging acid mucus, yuk, yuk. Jump to turn it aside.



◀ Olbis

It lives in the water. Sensing someone approaching, it comes out, flies high up in the air and zooms down to attack.



▲ Physical-strength target

In some cases, the soldier is given what we call "physical-strength target". It increases the physical strength by one unit.



▲ Kinohle

It is a manifestation of sand and propagates itself around Garloz. It discharges spores, walking like a crab.

10. EPILOGUE

In argool, there are many unexplored regions.

Unexplored region #1: The Tower of Garba

It is said that there is a mysterious tower in the back region in the Gran mountain.

Unexplored region #2: The drago room in the palace of Drago

It is said that in a mysterious island in Garloz, there is a palace where a drago is roaring. The room is called "Drago Room"

Unexplored region #3: The tower of Life

It is the highest tower in Argool. It is so high that it looks as if it reaches the sky.

Now you have just read this book through. But the real battle is yet to come. You must bring the brave Rygar to life from the dead in order to make Argool a peaceful land again. We hope you will succeed!

11. RESURRECTION

If Rygar is defeated by an enemy or his energy gets too low he will die. But don't be discouraged, by pressing the start button you can bring Rygar back to life again, and restart the game from the last point where you left off.

Press START button which allows the game to continue.

It's up to you! The enemies are strong, the terrain treacherous, and the challenges difficult. The sun is setting and Rygar is depending on your help to restore the peace again! Good Luck!!

90-DAY LIMITED WARRANTY TECMO GAME PAKS

90-DAY LIMITED WARRANTY:

Tecmo, Inc. ("Tecmo") warrants to the original consumer that this Tecmo Game Pak ("PAK") (not including Game Pak Accessories or Robot Accessories) shall be free from defect in material and workmanship for a period of 90 days from date of purchase. If a defect covered by this warranty occurs during 90-day warranty period, Tecmo will repair or replace the PAK, at its option, free of charge.

To receive this warranty service:

1. DO NOT return your defective Game Pak to the retailer.
2. Notify the Tecmo Consumer Division of the problem requiring warranty service by calling: 1-(800)457-6050. Our consumer Division is in operation from 8:00 A.M. to 5:00 P.M. Pacific Time, Monday through Friday.
3. If the Tecmo service technician is unable to solve the problem by phone, he will provide you with a Return Authorization number. Simply record this number on the outside packaging of your defective PAK, and return your PAK freight prepaid, at your risk of damage, together with your sales slip or similar proof-of-purchase within the 90-day warranty period to:

Tecmo, Inc. Consumer Division Victoria Business Park 18010 S. Adria Maru Lane Carson, CA 90746

This warranty shall not apply if the PAK has been damaged by negligence, accident, unreasonable use, modification, tampering, or by other causes unrelated to defective materials or workmanship.

REPAIRS AFTER EXPIRATION OF WARRANTY:

If the PAK develops problem after the 90-day warranty period, you may contact the Tecmo Consumer Division at the phone number noted above. If the Tecmo Service technician is unable to solve the problem by phone, he may provide you with a Return Authorization number. You may then record this number on the outside packaging of the defective PAK and return the defective PAK freight prepaid to Tecmo, enclosing a check or money order for \$10.00 payable to Tecmo, Inc. Tecmo will, at its option, subject to the conditions above, repair the PAK or replace it with a new or repaired PAK. If replacement PAKS are not available, the defective PAK will be returned and the \$10.00 payment refunded.

WARRANTY LIMITATIONS:

ANY APPLICABLE IMPLIED WARRANTIES, INCLUDING WARRANTIES OF MERCHANTABILITY AND FITNESS FOR A PARTICULAR PURPOSE, ARE HEREBY LIMITED TO NINETY DAYS FROM THE DATE OF PURCHASE AND ARE SUBJECT TO THE CONDITIONS SET FORTH HEREIN. IN NO EVENT SHALL TECMO BE LIABLE FOR CONSEQUENTIAL OR INCIDENTAL DAMAGES RESULTING FROM THE BREACH OF ANY EXPRESS OR IMPLIED WARRANTIES. The provisions of this warranty are valid in the United States only. Some states do not allow limitations on how long an implied warranty lasts or exclusion of consequential or incidental damages, so the above limitations and exclusion may not apply to you. This warranty gives you specific legal rights, and you may also have other rights which vary from state to state.

COMPLIANCE WITH FCC REGULATIONS

This equipment generates and uses radio frequency energy and if not installed and used properly, that is, in strict accordance with the manufacturers' instructions, may cause interference to radio and television reception. It has been type tested and found to comply with the limits for a Class B computing device in accordance with the specifications in Subpart J of Part 15 of FCC Rules, which are designed to provide reasonable protection against such interference in a residential installation. However, there is no guarantee that interference will not occur in a particular installation. If this equipment does cause interference to radio or television reception, which can be determined by turning the equipment off and on, the user is encouraged to try to correct the interference by one or more of the following measures:

- Reorient the receiving antenna
- Relocate the NES with respect to the receiver
- Move the NES away from the receiver
- Plug the NES into a different outlet so that computer and receiver are on different circuits.

If necessary, the user should consult the dealer or an experienced radio/television technician for additional suggestions. The user may find the following booklet prepared by the Federal Communication Commission helpful:

How to Identify and Resolve Radio - TV Interference Problems.

This booklet is available from the U.S. Government Printing Office, Washington, D.C. 20402, Stock No. 004-000-00345-4.

SPECIAL BONUS OFFER

Collect the TECMO game pak I.D. Badges for RYGAR and save! When you've collected a total of 5 TECMO game pak I.D. Badges, you can stick them with the enclosed stick-on seal and mail in to TECMO in order to receive Special bonus offer - It will be a gift you will love to share with your family and friends! For more information contact the TECMO, Inc., "Consumer Division Hotline", 1-(800) 457-6050.

MAIL DIRECTLY TO TECMO, INC.
ADDRESS LISTED
BELOW



Collect these and
other fine games from

TECMOTM

SEND
TO:

TECMO, INC.
18010 S. ADRIA MARU LANE
CARSON, CA 90746

Note: You must write down your name and address on the enclosed seal with block letters or by type-writing and mail together with STICK-ON SEAL in order to receive a surprised gift properly.

OFFICIAL I.D. BADGE →

